

ELISEE

Design: Castello Lagravinese Studio



TAVOLO - DINING TABLE

CARATTERISTICHE TECNICHE:

Struttura:
Noce Americano massello con crociera e terminali di ottone disponibili in diverse finiture.
Top :
Disponibile in un'ampia scelta di marmi esclusivi o in massello di noce Americano.

* Questo articolo può essere personalizzato su richiesta.

PRODUCT TECHNICAL SHEET:

Structure:
Solid American walnut with metal bars and end caps in brass available in different finish.
Top :
Available in a wide choice of exclusive marbles , or in solid American walnut.

* This item can be customized upon request.

TAVOLO OVALE / OVAL TABLE

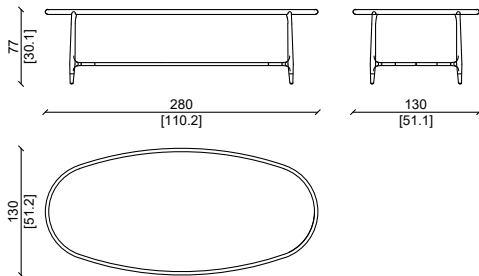

TAVOLO OVALE / OVAL TABLE

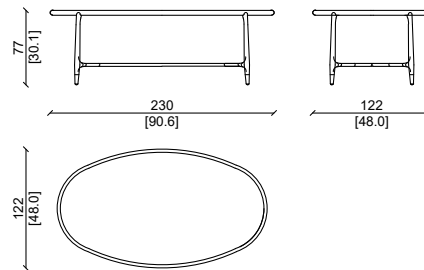

TAVOLO ROTONDO / ROUND TABLE

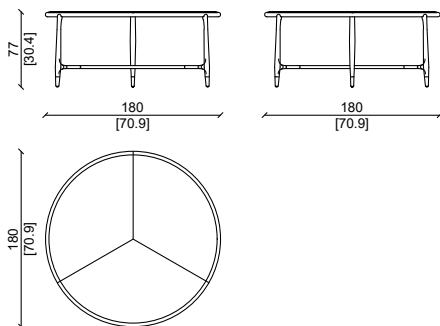

Struttura in noce Americano, crociera di ottone satinato top in marmo invisible grey.
American walnut structure, metal frame under top in satin brass, invisible grey marble top.

ELISEE

Design: Castello Lagravinese Studio



TAVOLO - DINING TABLE

CARATTERISTICHE TECNICHE:

Struttura:

Noce Americano massello con crociera e terminali di ottone disponibili in diverse finiture.

Top :

Disponibile in un'ampia scelta di marmi esclusivi o in massello di noce Americano o in vetro bronzato.

* Questo articolo può essere personalizzato su richiesta.

PRODUCT TECHNICAL SHEET:

Structure:

Solid American walnut with metal bars and end caps in brass available in different finish.

Top :

Available in a wide choice of exclusive marbles , or in solid American walnut, or bronze glass.

* This item can be customized upon request.

TOP IN MARMO - MARBLE TOP

TAVOLO RETT. / RECT. TABLE

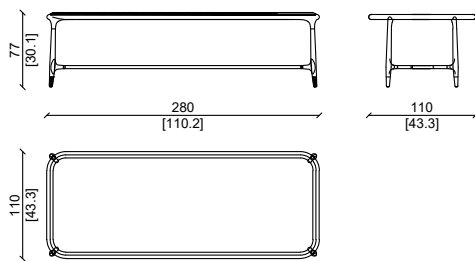

TAVOLO RETT. / RECT. TABLE

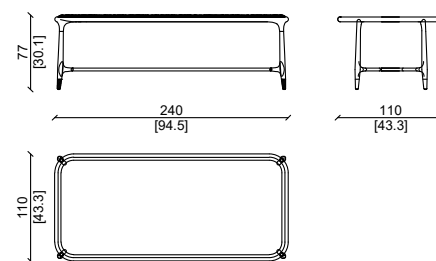

TOP IN VETRO - GLASS TOP

TAVOLO RETT. / RECT. TABLE

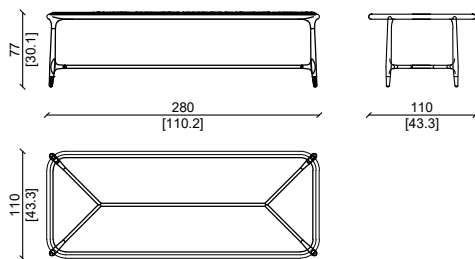

TAVOLO RETT. / RECT. TABLE

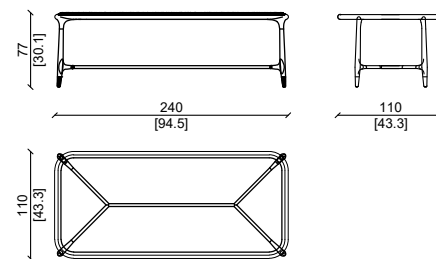

Struttura in frassino cenere, inserti in metallo e piano in marmo calacatta gold.
Ash cenere structure, satin brass inserts and calacatta gold marble.

τ



Struttura in noce americano, inserti in metallo e piano in vetro bronzato.
American walut structure, satin brass inserts and bronze glass top.